

MIG Toortsen TBI Classic-reeks

TBI 150 Classic Gasekoeld

4.2

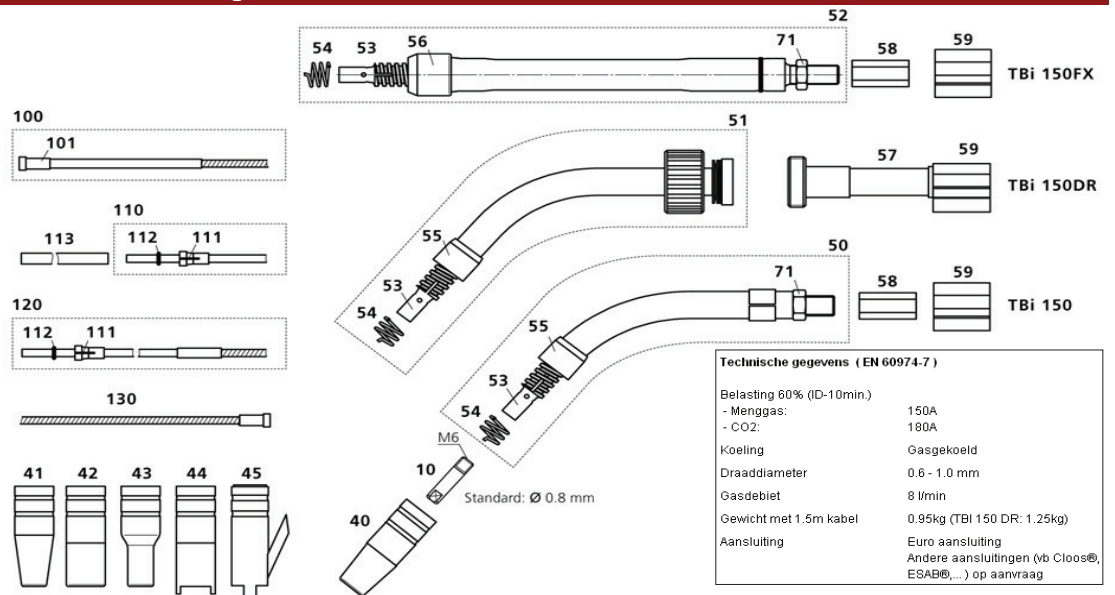

| Pos. nr. | Bestelnummer | Omschrijving | EC | VPE |
|-----------------------|--------------|---|------|-------|
| | T2383013 | Migtoorts TBI 150A x 3M | stuk | 1 |
| | T2383014 | Migtoorts TBI 150A x 4M | stuk | 1 |
| | T2383015 | Migtoorts TBI 150A x 5M | stuk | 1 |
| Gasmondstukken | | | | |
| 40 | T2378330 | Gasmondstuk konisch ID 12,0 | stuk | 2/10 |
| 41 | T2378332 | Gasmondstuk sterk konisch ID 9,5 | stuk | 2/10 |
| 42 | T2378328 | Gasmondstuk cilindrisch ID 16 + verl.isolatie | stuk | 2/10 |
| 43 | T2378333 | Gasmondstuk flesvormig ID 13,0 | stuk | 2/10 |
| 44 | T2378334 | Puntlas gasmondstuk ID 16,0 | stuk | 2/10 |
| Kontakttips | | | | |
| 10 | T2378380 | Kontakttip M6 0.6mm 6.3x25mm | stuk | 10/50 |
| 10 | T2378381 | Kontakttip M6 0.8mm 6.3x25mm | stuk | 10/50 |
| 10 | T2378382 | Kontakttip M6 1.0mm 6.3x25mm | stuk | 10/50 |
| Liners | | | | |
| 100 | T2378294 | Liner PC blauw 3M 0,6-0,9mm | stuk | 1/5 |
| 100 | T2378295 | Liner PC blauw 4M 0,6-0,9mm | stuk | 1/5 |
| 100 | T2378296 | Liner PC blauw 5M 0,6-0,9mm | stuk | 1/5 |
| Diversen | | | | |
| 50 | T2378304 | Zwanehals TBI150 | stuk | 1 |
| 53 | T2378309 | Kontakttiphouder TBI150 | stuk | 2/10 |
| 54 | T2378307 | Veertje | stuk | 10 |
| 55 | T2378306 | Beschermhuls TBI150 | stuk | 2/10 |
| | T2378310 | Afdichtingsring | stuk | 2/10 |
| 58 | T2378325 | Tussenlichaam messing | stuk | 2/10 |
| 59 | T2378324 | Tussenlichaam Plastiek | stuk | 2/10 |
| | T2378360 | Slangenpakket 3M 150A | stuk | 1 |
| | T2378370 | Slangenpakket 4M 150A | stuk | 1 |
| | T2378365 | Slangenpakket 5M 150A | stuk | 1 |

TBi 240 Classic Gasgekoeld

4.2

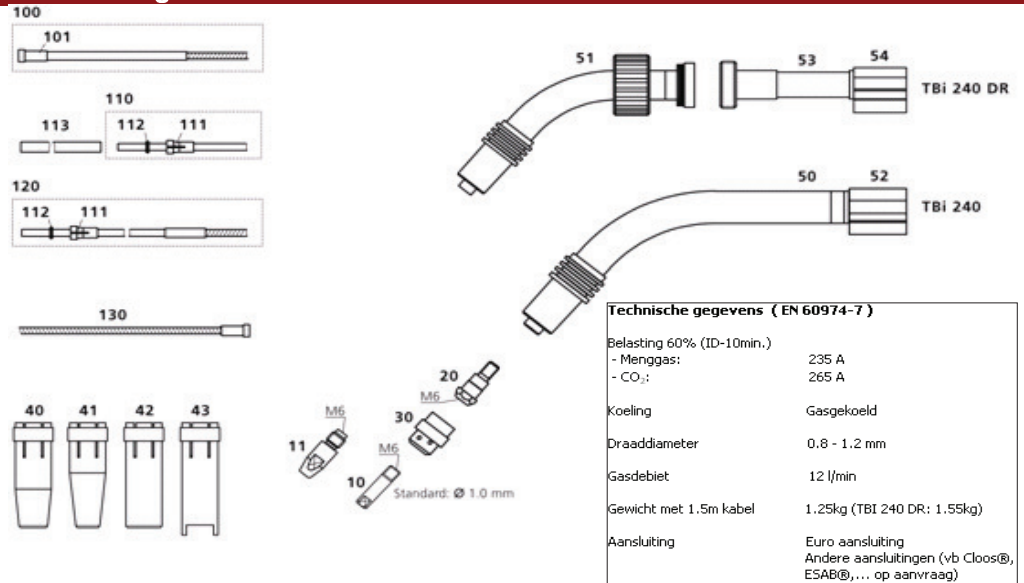

| Pos. nr. | Bestelnummer | Omschrijving | EC | VPE |
|-----------------------|----------------------|-------------------------------------|-------------|--------------|
| | T2383003 | Migtoorts TBi 240 x 3M | stuk | 1 |
| | T2383004 | Migtoorts TBi 240 x 4M | stuk | 1 |
| | T2383005EX | Toorts Tbi 240/5m M6 Expert | stuk | 1 |
| Gasmondstukken | | | | |
| 40 | T2378222 | Gasmondstuk konisch ID 12,5 | stuk | 2/10 |
| 41 | T2378641 | Gasmondstuk konisch ID 10 | stuk | 2/10 |
| 42 | T2378631 | Gasmondstuk cilindrisch ID 17 | stuk | 2/10 |
| Kontakttips | | | | |
| 11 | T2378481 | Kontakttip M6 0.8mm | stuk | 10/50 |
| 11 | T2378482 | Kontakttip M6 1.0mm | stuk | 10/50 |
| 11 | T2378483 | Kontakttip M6 1.2mm | stuk | 10/50 |
| 11 | T2378487 | Kontakttip M6 0.8mm CuCrZr | stuk | 10/50 |
| 11 | T2378486 | Kontakttip M6 1.0mm CuCrZr | stuk | 10/50 |
| 11 | T2378489 | Kontakttip M6 1.2mm CuCrZr | stuk | 10/50 |
| Liners | | | | |
| 100 | T2378294 | Liner PC blauw 3M 0,6-0,9mm | stuk | 1/5 |
| 100 | T2378295 | Liner PC blauw 4M 0,6-0,9mm | stuk | 1/5 |
| 100 | T2378296 | Liner PC blauw 5M 0,6-0,9mm | stuk | 1/5 |
| 100 | T2378094 | Liner PC rood 3M 1,0-1,2mm | stuk | 1/5 |
| 100 | T2378095 | Liner PC rood 4M 1,0-1,2mm | stuk | 1/5 |
| 100 | T2378093 | Liner PC rood 5M 1,0-1,2mm | stuk | 1/5 |
| Diversen | | | | |
| 30 | TBI112P002019 | Gasverdeler rubber rood | stuk | 10/50 |
| | TBI112P002024 | Gasverdeler 240/241 Zwart Duroplast | stuk | 10/50 |
| 20 | T2378223 | Kontaktthouder M6 | stuk | 2/10 |
| 50 | T2378520 | Zwanehals TBi240 | stuk | 1 |
| | TBI361PXL1130 | Slangenpakket Proflex XL 3m | stuk | 1 |
| | T2378142 | Slangenpakket 240A 4m | stuk | 1 |
| | T2378143 | Slangenpakket 240A 5M | stuk | 1 |

MIG Toortsen TBi Classic-reeks

TBi 250 Classic Gasgekoeld

4.2

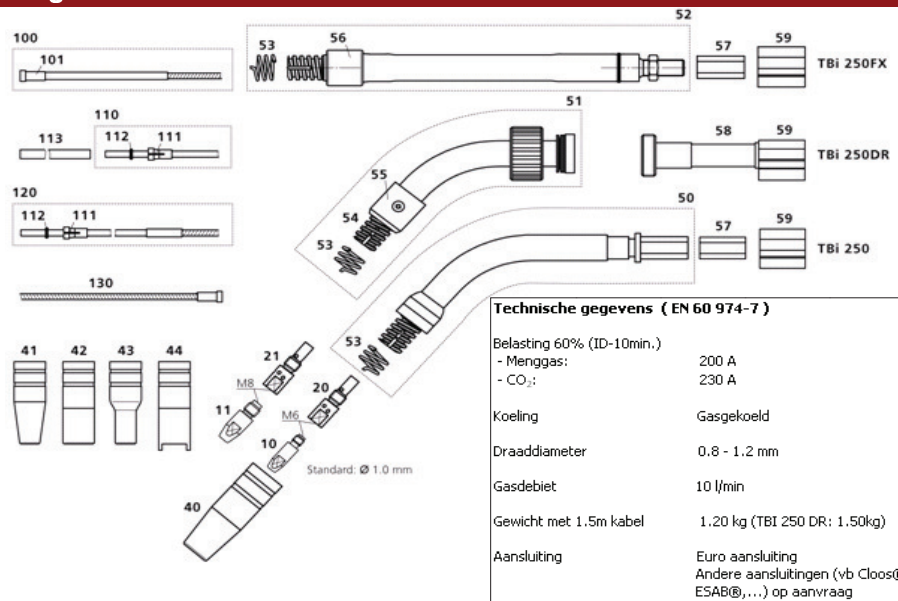

| Pos. nr. | Bestelnummer | Omschrijving | EC | VPE |
|-----------------------|-----------------|--------------------------------------|-------------|--------------|
| | T2383023 | Mig Toorts TBi 250 x 3M | stuk | 1 |
| | T2383024 | Mig Toorts TBi 250 x 4M | stuk | 1 |
| | T2383025 | Mig Toorts TBi 250 x 5M | stuk | 1 |
| Gasmondstukken | | | | |
| 40 | T2378528 | Gasmondstuk konisch ID 15,0 | stuk | 2/10 |
| 42 | T2378426 | Gasmondstuk cilindrisch ID 18,0 | stuk | 2/10 |
| 41 | T2378530 | Gasmondstuk sterk konisch ID 11,5 | stuk | 2/10 |
| 44 | T2378427 | Puntlas gasmondstuk ID 20 | stuk | 2/10 |
| Kontakttips | | | | |
| 10 | T2378481 | Kontakttip M6 0.8mm | stuk | 10/50 |
| 10 | T2378482 | Kontakttip M6 1.0mm | stuk | 10/50 |
| 10 | T2378487 | Kontakttip M6 0.8mm CuCrZr | stuk | 10/50 |
| 10 | T2378486 | Kontakttip M6 1.0mm CuCrZr | stuk | 10/50 |
| Liners | | | | |
| 100 | T2378294 | Liner PC blauw 3M 0,6-0,9mm | stuk | 1/5 |
| 100 | T2378295 | Liner PC blauw 4M 0,6-0,9mm | stuk | 1/5 |
| 100 | T2378296 | Liner PC blauw 5M 0,6-0,9mm | stuk | 1/5 |
| 100 | T2378094 | Liner PC rood 3M 1,0-1,2mm | stuk | 1/5 |
| 100 | T2378095 | Liner PC rood 4M 1,0-1,2mm | stuk | 1/5 |
| 100 | T2378093 | Liner PC rood 5M 1,0-1,2mm | stuk | 1/5 |
| Diversen | | | | |
| 20 | T2378403 | Kontaktbuis houder M6 35,25mm | stuk | 2/10 |
| 21 | T2378407 | Kontaktbuis houder M8 35,25mm | stuk | 2/10 |
| 53 | T2378532 | Veertje | stuk | 10 |
| 50 | T2378404 | Zwanehals TBi250 | stuk | 1 |
| 59 | T2378324 | Tussenlichaam Plastiek | stuk | 2/10 |
| | T2378413 | slangenpakket 3M 250 | stuk | 1 |
| | T2378414 | slangenpakket 4M 250 | stuk | 1 |
| | T2378415 | slangenpakket 5M 250 | stuk | 1 |

MIG Toortsen TBi Classic-reeks

TBi 260 Classic Gasgekoeld

4.2

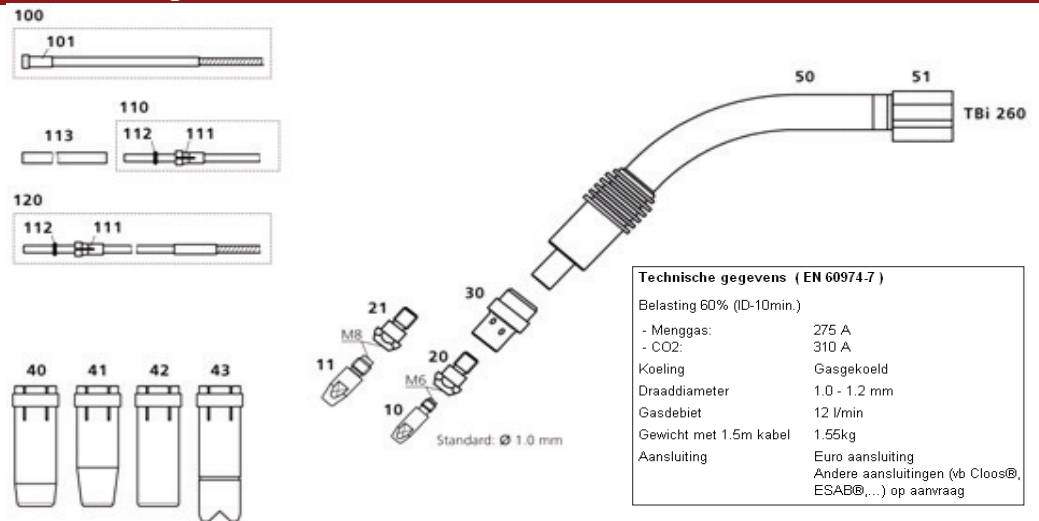

| Pos. nr. | Bestelnummer | Omschrijving | EC | VPE |
|-----------------------|---------------|---------------------------------|------|-------|
| | T2383033 | Migtoorts TBi 260A x 3M | stuk | 1 |
| | T2383034 | Migtoorts TBi 260A x 4M | stuk | 1 |
| | T2383035 | Migtoorts TBi 260A x 5M | stuk | 1 |
| Gasmondstukken | | | | |
| 40 | T2378729 | Gasmondstuk konisch ID 16,0 | stuk | 2/10 |
| 41 | T2378530 | Gasmondstuk konisch ID 14 | stuk | 2/10 |
| 42 | T2378730 | Gasmondstuk cilindrisch ID 20,0 | stuk | 2/10 |
| Kontakttips | | | | |
| 10 | T2378481 | Kontakttip M6 0.8mm | stuk | 10/50 |
| 10 | T2378482 | Kontakttip M6 1.0mm | stuk | 10/50 |
| 10 | T2378483 | Kontakttip M6 1.2mm | stuk | 10/50 |
| 10 | T2378487 | Kontakttip M6 0.8mm CuCrZr | stuk | 10/50 |
| 10 | T2378486 | Kontakttip M6 1.0mm CuCrZr | stuk | 10/50 |
| 10 | T2378489 | Kontakttip M6 1.2mm CuCrZr | stuk | 10/50 |
| Liners | | | | |
| 100 | T2378294 | Liner PC blauw 3M 0,6-0,9mm | stuk | 1/5 |
| 100 | T2378295 | Liner PC blauw 4M 0,6-0,9mm | stuk | 1/5 |
| 100 | T2378296 | Liner PC blauw 5M 0,6-0,9mm | stuk | 1/5 |
| 100 | T2378094 | Liner PC rood 3M 1,0-1,2mm | stuk | 1/5 |
| 100 | T2378095 | Liner PC rood 4M 1,0-1,2mm | stuk | 1/5 |
| 100 | T2378093 | Liner PC rood 5M 1,0-1,2mm | stuk | 1/5 |
| Diversen | | | | |
| 20 | T2378183 | Kontakttiphouder M6 | stuk | 2/10 |
| 21 | T2378679 | Kontakttiphouder M8 | stuk | 2/10 |
| 30 | T2378108 | Gasverdeler wit | stuk | 10/5 |
| 50 | T2378104 | Zwanehals TBi260A | stuk | 1 |
| 51 | T2378324 | Tussenlichaam Plastiek | stuk | 2/10 |
| | TBI361PXL1130 | Slangenpakket Proflex XL 3m | stuk | 1 |
| | T2378142 | Slangenpakket 260A 4m | stuk | 1 |
| | T2378143 | Slangenpakket 260A 5m | stuk | 1 |

MIG Toortsen TBi Classic-reeks

TBi 360 Classic Gasgekoeld

4.2

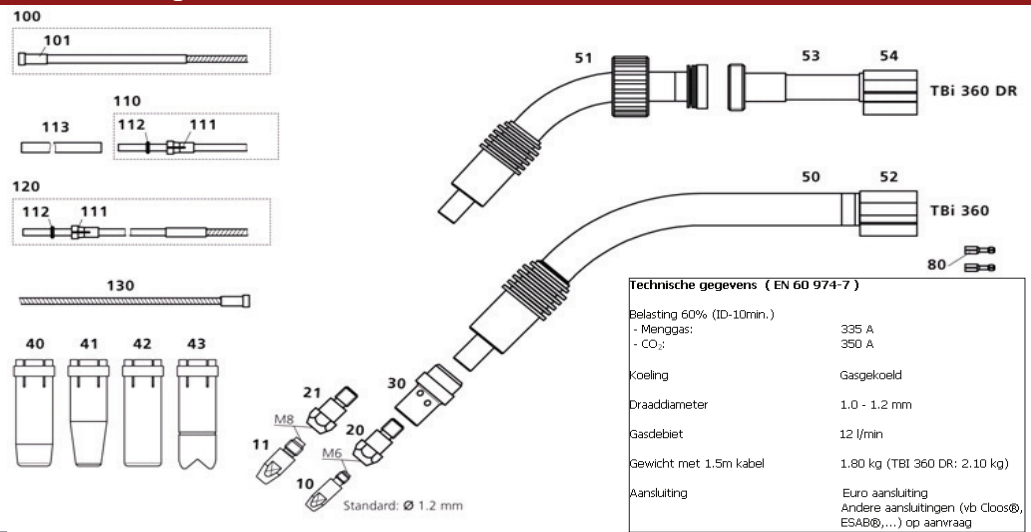

| Pos. nr. | Bestelnummer | Omschrijving | EC | VPE |
|-----------------------|---------------|------------------------------------|-------------|--------------|
| | T2383046 | Migtoorts TBi 360A x 3M (M6) | stuk | 1 |
| | T2383047 | Migtoorts TBi 360A x 4M (M6) | stuk | 1 |
| | T2383046 | Migtoorts TBi 360A x 3M (M8) | stuk | 1 |
| | T2383047 | Migtoorts TBi 360A x 4M (M8) | stuk | 1 |
| | T2383048 | Migtoorts TBi 360A x 5M (M8) | stuk | 1 |
| Gasmondstukken | | | | |
| 40 | T2378203 | Gasmondstuk konisch ID 16,0 | stuk | 2/10 |
| 41 | T2378290 | Gasmondstuk sterk konisch ID 12,0 | stuk | 2/10 |
| 42 | T2378288 | Gasmondstuk cilindrisch ID 19,0 | stuk | 2/10 |
| Kontakttips | | | | |
| 10 | T2378482 | Kontakttip M6 1.0mm | stuk | 10/50 |
| 10 | T2378483 | Kontakttip M6 1.2mm | stuk | 10/50 |
| 10 | T2378484 | Kontakttip M6 1.6mm | stuk | 10/50 |
| 10 | T2378486 | Kontakttip M6 1.0mm CuCrZr | stuk | 10/50 |
| 10 | T2378489 | Kontakttip M6 1.2mm CuCrZr | stuk | 10/50 |
| 10 | T2378488 | Kontakttip M6 1.6mm CuCrZr | stuk | 10/50 |
| 11 | T2378881 | Kontakttip M8 1.0mm 10x30mm | stuk | 10/50 |
| 11 | T2378880 | Kontakttip M8 1.2mm 10x30mm | stuk | 10/50 |
| 11 | T2378883 | Kontakttip M8 1.6mm 10x30mm | stuk | 10/50 |
| 11 | T2378879 | Kontakttip M8 1.0mm CuCrZr 10x30mm | stuk | 10/50 |
| 11 | T2378885 | Kontakttip M8 1.2mm CuCrZr 10x30mm | stuk | 10/50 |
| 11 | T2378882 | Kontakttip M8 1.6mm CuCrZr 10x30mm | stuk | 10/50 |
| Liners | | | | |
| 100 | T2378094 | Liner PC rood 3M 1,0-1,2mm | stuk | 1/5 |
| 100 | T2378095 | Liner PC rood 4M 1,0-1,2mm | stuk | 1/5 |
| 100 | T2378096 | Liner PC geel 3M 1.6mm | stuk | 1/5 |
| 100 | T2378097 | Liner PC geel 4M 1.6mm | stuk | 1/5 |
| Diversen | | | | |
| 20 | T2378283 | Kontaktbuis houder M6 28mm | stuk | 2/10 |
| 20 | T2378284 | Kontaktbuis houder M6 32mm | stuk | 2/10 |
| 21 | T2378205 | Kontaktbuis houder M8 28mm | stuk | 2/10 |
| 30 | T2378208 | Gasverdeler zwart | stuk | 10/50 |
| 50 | T2378204 | Toortselichaam 360A | stuk | 1 |
| | TBI361PXL1130 | Slangenpakket Proflex XL 3m | stuk | 1 |
| | TBI361PXL1140 | Slangenpakket TBi Proflex XL 4m | stuk | 1 |

TBi 411 511 Watergekoeld

4.2

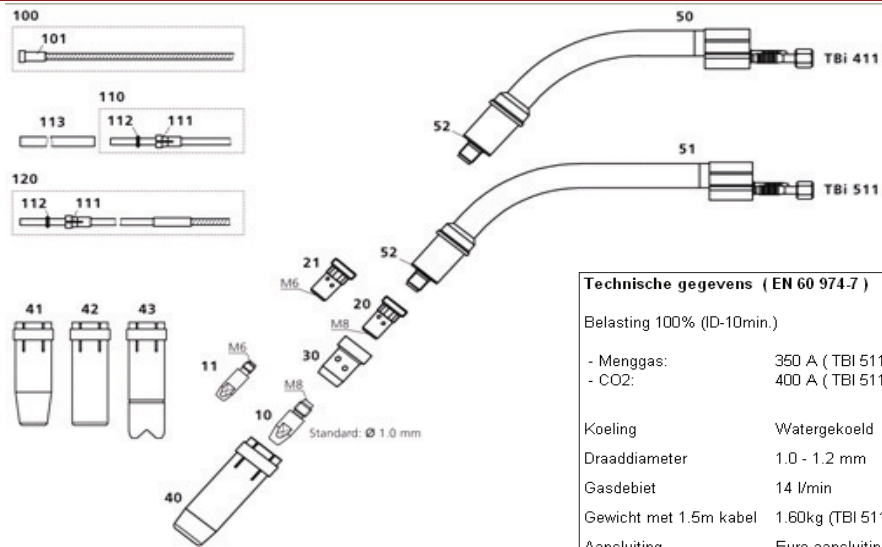

Technische gegevens (EN 60 974-7)

Belasting 100% (ID-10min.)

- Menggas: 350 A (TBi 511:450 A)
- CO₂: 400 A (TBi 511:500 A)

Koeling Watergekoeld

Draad diameter 1.0 - 1.2 mm

Gasdebiet 14 l/min

Gewicht met 1.5m kabel 1.60kg (TBi 511: 1.65kg)

Aansluiting Euro aansluiting
Andere aansluitingen (vb Cloos®, ESAB®...) op aanvraag

| Pos. nr. | Bestelnummer | Omschrijving | EC | VPE |
|-----------------------|-----------------|---|-------------|--------------|
| | T2383053EX | Toorts Tbi 411/3m Wk Expert Plus | stuk | 1 |
| | T2383054 | Migtoorts TBi 411W x 4M | stuk | 1 |
| | T2383055EX | Toorts Tbi 411/5m Wk Expert Plus | stuk | 1 |
| | T2383083 | Migtoorts TBi 511W x 3M | stuk | 1 |
| | T2383084 | Migtoorts TBi 511W x 4M | stuk | 1 |
| | T2383085 | Migtoorts TBi 511W x 5M | stuk | 1 |
| Gasmondstukken | | | | |
| 40 | T2378729 | Gasmondstuk konisch ID 16,0 | stuk | 2/10 |
| 41 | T2378728 | Gasmondstuk konisch ID 14,0 mm | stuk | 2/10 |
| 42 | T2378730 | Gasmondstuk cilindrisch ID 20,0 | stuk | 2/10 |
| Kontakt tips | | | | |
| 10 | T2378877 | Kontakt tip M8 0.8mm 10x30mm | stuk | 10/50 |
| 10 | T2378881 | Kontakt tip M8 1.0mm 10x30mm | stuk | 10/50 |
| 10 | T2378880 | Kontakt tip M8 1.2mm 10x30mm | stuk | 10/50 |
| 10 | T2378883 | Kontakt tip M8 1.6mm 10x30mm | stuk | 10/50 |
| 11 | T2378878 | Kontakt tip M8 .08mm CuCrZr 10x30mm | stuk | 10/50 |
| 11 | T2378879 | Kontakt tip M8 1.0mm CuCrZr 10x30mm | stuk | 10/50 |
| 11 | T2378885 | Kontakt tip M8 1.2mm CuCrZr 10x30mm | stuk | 10/50 |
| 11 | T2378882 | Kontakt tip M8 1.6mm CuCrZr 10x30mm | stuk | 10/50 |
| Liners | | | | |
| 100 | T2378785 | Liner 3M 1.0-1.2mm | stuk | 1/5 |
| 100 | T2378795 | Liner 4M 1.0-1.2mm | stuk | 1/5 |
| 100 | T2378778 | Liner 5M 1.0-1.2mm | stuk | 1/5 |
| 100 | T2378784 | Liner 3M 1.4-1.6mm | stuk | 1/5 |
| 100 | T2378794 | Liner 4M 1.4-1.6mm | stuk | 1/5 |
| 100 | T2378792 | Liner 5M 1.4-1.6mm | stuk | 1/5 |
| Diversen | | | | |
| 20 | T2378774 | Kontakt tip houder 25mm M8 | stuk | 2/10 |
| 30 | T2378699 | Gasverdeler zwart met schroefdraad 7G+W/9W/411/511 | stuk | 10/50 |
| 30 | T2378708 | Gasverdeler wit | stuk | 50/500 |
| 50 | T2378693 | Zwanehals TBi 411W | stuk | 1 |
| 51 | T2378705 | Zwanehals TBi 511W | stuk | 1 |

MIG Toortsen TBI Classic-reeks

TBI 511-CC Expert

4.2

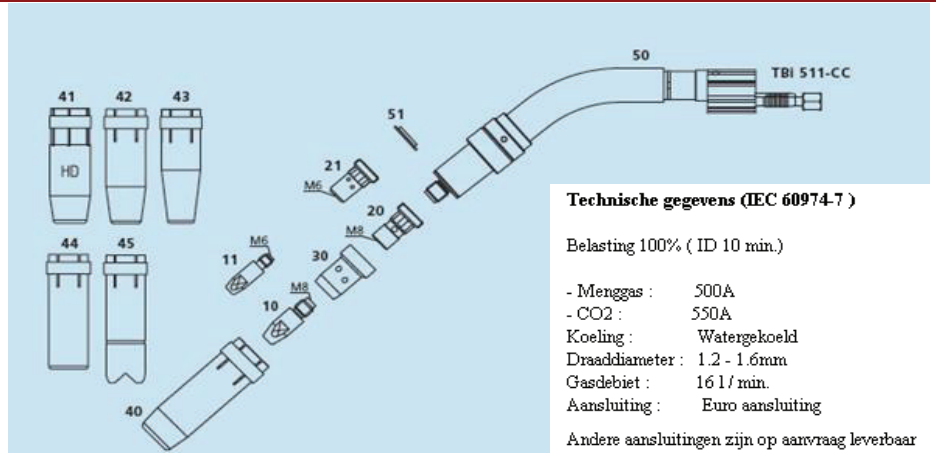

| Pos. nr. | Bestelnummer | Omschrijving | EC | VPE |
|---------------------|----------------------|---|-------------|--------------|
| | TBI175P421030 | Migtoorts TBI 511/3m CC Expert Wk | stuk | 1 |
| | TBI175P421040 | Migtoorts TBI 511/4m CC Expert Wk | stuk | 1 |
| | TBI175P421050 | Migtoorts TBI 511/5m CC Expert Wk | stuk | 1 |
| 40 | T2378729 | Gasmondstuk konisch 16,0 | stuk | 2/10 |
| 41 | T2378728 | Gasmondstuk konisch HD 16 mm L=75.5mm | stuk | 2/10 |
| 42 | T2378728 | Gasmondstuk konisch 14.0 mm L=75.5mm | stuk | 2/10 |
| 44 | T2378730 | Gasmondstuk Cylindrisch 20.0 L=75.5mm | stuk | 2/10 |
| 45 | T2378727 | Gasmondstuk Puntlas 20.0 L=85mm | stuk | 2/10 |
| Kontakt tips | | | | |
| 10 | T2378877 | Kontakt tip M8 0.8mm 10x30mm | stuk | 10/50 |
| 10 | T2378881 | Kontakt tip M8 1.0mm 10x30mm | stuk | 10/50 |
| 10 | T2378880 | Kontakt tip M8 1.2mm 10x30mm | stuk | 10/50 |
| 10 | T2378883 | Kontakt tip M8 1.6mm 10x30mm | stuk | 10/50 |
| 10 | T2378878 | Kontakt tip M8 .08mm CuCrZr 10x30mm | stuk | 10/50 |
| 10 | T2378879 | Kontakt tip M8 1.0mm CuCrZr 10x30mm | stuk | 10/50 |
| 10 | T2378885 | Kontakt tip M8 1.2mm CuCrZr 10x30mm | stuk | 10/50 |
| 10 | T2378882 | Kontakt tip M8 1.6mm CuCrZr 10x30mm | stuk | 10/50 |
| Liners | | | | |
| 100 | T2378785 | Liner 3M 1.0-1.2mm | stuk | 1/5 |
| 100 | T2378795 | Liner 4M 1.0-1.2mm | stuk | 1/5 |
| 100 | T2378778 | Liner 5M 1.0-1.2mm | stuk | 1/5 |
| 100 | T2378784 | Liner 3M 1.4-1.6mm | stuk | 1/5 |
| 100 | T2378794 | Liner 4M 1.4-1.6mm | stuk | 1/5 |
| 100 | T2378792 | Liner 5M 1.4-1.6mm | stuk | 1/5 |
| Diversen | | | | |
| 20 | TBI342P008171 | Kontakt tip houder 25mm M8 CuCrZr | stuk | 2/10 |
| 20 | T2378774 | Kontakt tip houder 25mm M8 | stuk | 2/10 |
| 20 | T2378776 | Kontakt tip houder 29mm M8 | stuk | 2/10 |
| 30 | T2378699 | Gasverdeler zwart met schroefdraad 7G+W/9W/411/511 | stuk | 10/50 |
| 50 | TBI175P101001 | Zwanehals TBI 511-CC Expert | stuk | 1 |
| 51 | TBI175P102005 | Isoleerbus TBI 511-CC Expert | stuk | 1 |

MIG Toortsen TBI Classic-reeks

XP 463-S

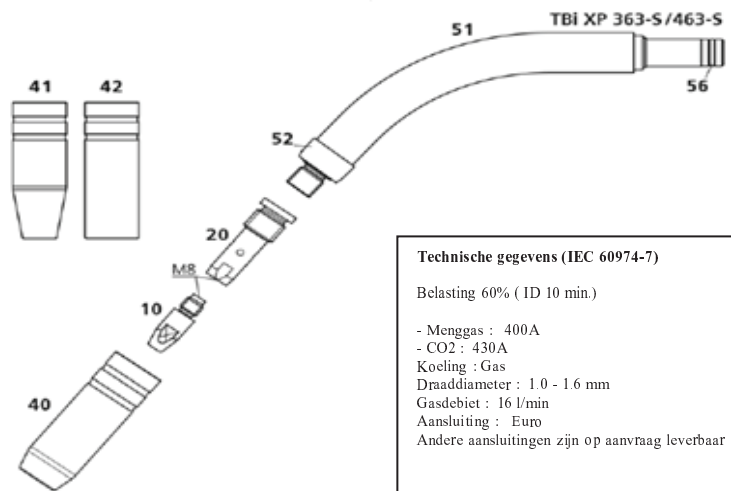

Technische gegevens (IEC 60974-7)

Belasting 60% (1D 10 min.)

- Menggas : 400A

- CO2 : 430A

Koeling : Gas

Draad diameter : 1.0 - 1.6 mm

Gasdebiet : 16 l/min

Aansluiting : Euro

Andere aansluitingen zijn op aanvraag leverbaar

| Pos. nr. | Bestelnummer | CODE | Omschrijving | VPE | VPE | |
|-----------------------|----------------------|----------------|---------------------------------------|--|-------------|--------------|
| | TBI145P321030 | B 4400 | Migtoorts TBI XP 463-S, 3m | stuk | 1 | |
| | TBI145P321040 | A 4400 | Migtoorts TBI XP 463-S, 4m | stuk | 1 | |
| | TBI145P321050 | D 4400 | Migtoorts TBI XP 463-S, 5m | stuk | 1 | |
| Gasmondstukken | | | | | | |
| 40 | TBI345P022045 | A 4400P | Gasmondstuk konisch 15 XP463 | stuk | 5/25 | |
| 41 | TBI345P021045 | B 4400 | Gasmondstuk konisch HD 16 mm L=75.5mm | stuk | 5/25 | |
| 42 | TBI345P023045 | B 4400 | Gasmondstuk konisch 14.0 mm L=75.5mm | stuk | 5/25 | |
| Kontakttips | | | | | | |
| 10 | T2378877 | 340p081262 | B 4400P | Kontaktbuis 0.8 M8 10X30mm | stuk | 10/50 |
| 10 | T2378881 | 340p101262 | A 4400P | Kontaktbuis 1.0 M8 10X30mm | stuk | 10/50 |
| 10 | T2378880 | 340p121262 | A 4400P | Kontaktbuis 1.2 M8 10X30mm | stuk | 10/50 |
| 10 | T2378883 | 340p161262 | B 4400P | Kontaktbuis 1.6 M8 10X30mm | stuk | 10/50 |
| 10 | T2378878 | 340p083262 | C 4400P | Kontaktbuis 0.8 M8 Cucrzr 10X30mm | stuk | 10/50 |
| 10 | T2378879 | 340p103262 | A 4400P | Kontaktbuis 1.0 M8 Cucrzr 10X30mm | stuk | 10/50 |
| 10 | T2378885 | 340p123262 | A 4400P | Kontaktbuis 1.2 M8 Cucrzr 10X30mm | stuk | 10/50 |
| 10 | T2378882 | 340p163262 | C 4400P | Kontaktbuis 1.6 M8 Cucrzr 10X30mm | stuk | 10/50 |
| Liners | | | | | | |
| 100 | T2378094 | 324P204534 | B 4400 | Liner PC rood 3M 1,0-1,2mm | stuk | 1/5 |
| 100 | T2378095 | 324P204544 | A 4400 | Liner PC rood 4M 1,0-1,2mm | stuk | 1/5 |
| 100 | T2378096 | 324P254534 | D 4400 | Liner PC geel 3M 1.6mm | stuk | 1/5 |
| 100 | T2378097 | 324P254544 | D 4400 | Liner PC geel 4M 1.6mm | stuk | 1/5 |
| Diversen | | | | | | |
| 20 | TBI145P102008 | | 4400 | Kontaktbuis houder M8 | stuk | 2/10 |
| 51 | TBI145P101001 | | 4400 | Zwanehals 45° | stuk | 1 |
| 52 | TBI145P102004 | | 4400 | Isolator XP 463 | stuk | 1/5 |
| 70 | 361PXLS130 | | 4400 | Slangenpakket TBI ProFlex XL, 3m | stuk | 1 |
| 70 | 361PXLS140 | | 4400 | Slangenpakket TBI ProFlex XL, 4m | stuk | 1 |
| 70 | 361PXLS150 | | 4400 | Slangenpakket TBI ProFlex XL, 5m | stuk | 1 |

TBi 9W - M10 4.2

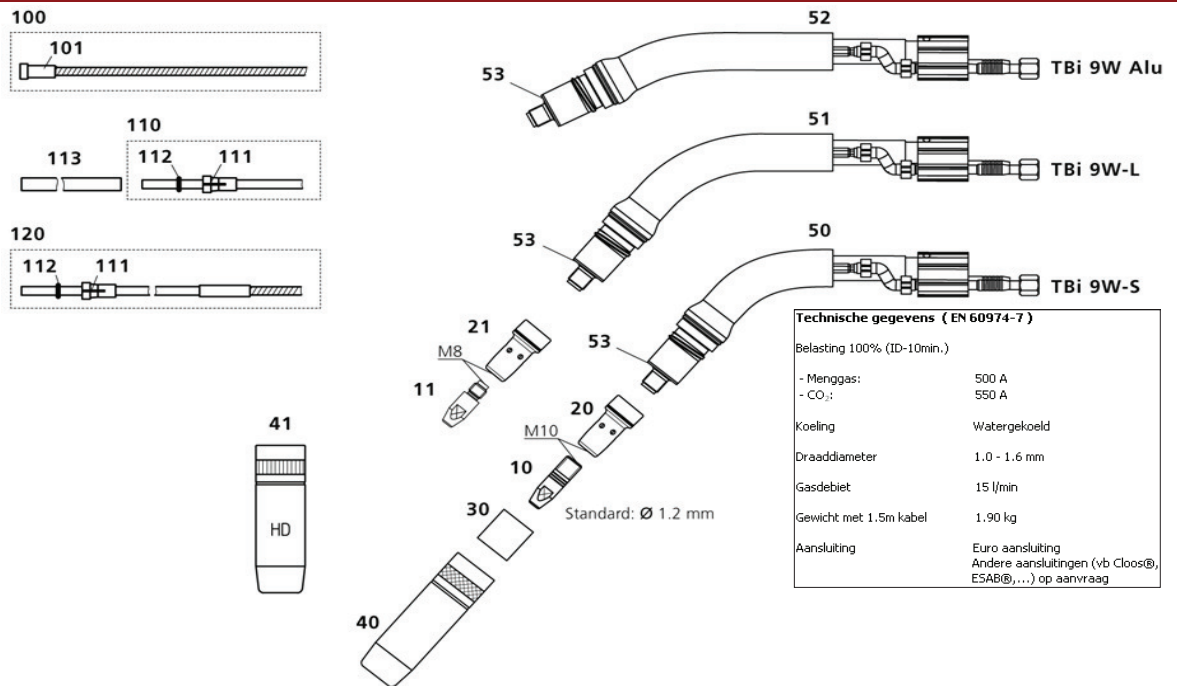

| Pos. nr. | Bestelnummer | Omschrijving | EC | VPE |
|-----------------------|----------------------|--|-------------|--------------|
| Gasmondstukken | | | | |
| 40 | TBI345P022173 | Gasmondstuk konisch 16.0 verchroomd 9 W | stuk | 2/5 |
| 41 | TBI345P922271 | Gasmondstuk konisch 16.0 HD 9 W | stuk | 2/5 |
| Kontakttips | | | | |
| 10 | TBI340P083400 | Kontaktbuis 0.8 M10 Ecu L = 33mm | stuk | 10/50 |
| 10 | TBI340P103401 | Kontaktbuis 1.0 M10 Ecu L = 33mm | stuk | 10/50 |
| 10 | TBI340P121402 | Kontaktbuis 1.2 M10 Ecu L = 33mm | stuk | 10/50 |
| 10 | TBI340P161403 | Kontaktbuis 1.6 M10 Ecu L = 33mm | stuk | 10/50 |
| 11 | T2378892 | Kontaktbuis 0.8 M8 Alu 10X30mm | stuk | 10/50 |
| 11 | T2378891 | Kontaktbuis 1.0 M8 Alu 10X30mm | stuk | 10/50 |
| 11 | T2378894 | Kontaktbuis 1.2 M8 Alu 10X30mm | stuk | 10/50 |
| 11 | T2378893 | Kontaktbuis 1.6 M8 Alu 10X30mm | stuk | 10/50 |
| Tiphouders | | | | |
| 20 | TBI342P010071 | Kontaktbuishouder 9W M10 L27 CuCrZr | stuk | 2/10 |
| 21 | TBI342P008071 | Kontaktbuishouder 9W M8 L30 CuCrZr (std bij Alu) | stuk | 2/10 |
| Gasverdeler | | | | |
| 30 | TBI346P054860 | Gasverdeler M10 9W speciaal | stuk | 2/10 |

MIG toortsen 9W

TBi 9W - M8

4.2

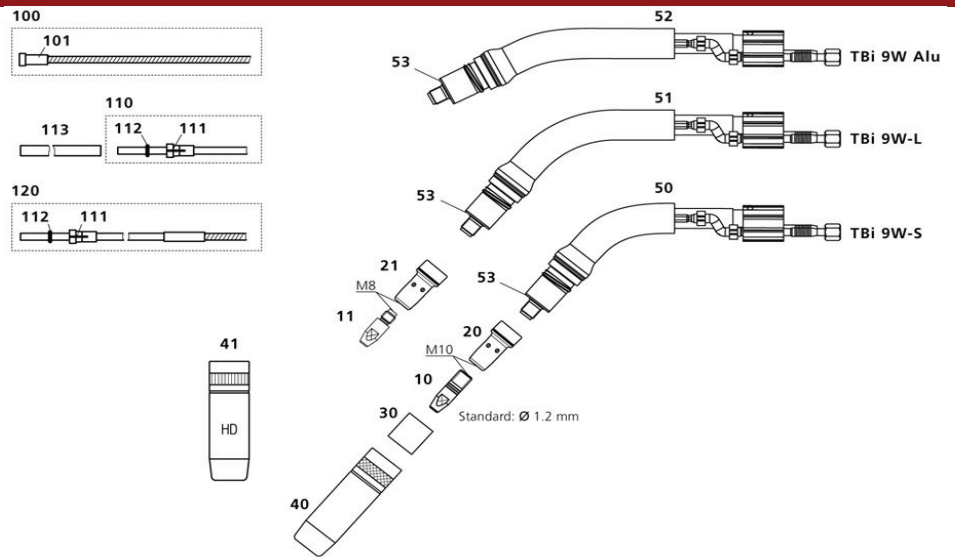

| Pos. nr. | Bestelnummer | Omschrijving | EC | VPE |
|--|---------------|--|-------------|--------------|
| Toortsen (niet meer verkrijgbaar) | | | | |
| | TBI9W3KM8 | Toorts 9W 3M | stuk | 1 |
| | TBI9W4KM8EX | Toorts 9W-S/4M Wk Expert korte hals M8 | stuk | 1 |
| Gasmondstukken | | | | |
| 40 | TBI345P022171 | Gasmondstuk konisch 16.0 7W/9W | stuk | 2/5 |
| 41 | TBI345P022271 | Gasmondstuk konisch HD 16.0 7W/9W | stuk | 2/5 |
| 42 | TBI345P023171 | Gasmondstuk sterk konisch 14.0 7W/9W | stuk | 2/5 |
| 43 | TBI345P021171 | Gasmondstuk cilindrisch 19.0 7W/9W | stuk | 2/5 |
| Kontakttips | | | | |
| 10 | T2378877 | Kontaktbuis 0.8 M8 10X30mm | stuk | 10/50 |
| 10 | T2378881 | Kontaktbuis 1.0 M8 10X30mm | stuk | 10/50 |
| 10 | T2378880 | Kontaktbuis 1.2 M8 10X30mm | stuk | 10/50 |
| 10 | T2378883 | Kontaktbuis 1.6 M8 10X30mm | stuk | 10/50 |
| 10 | T2378892 | Kontaktbuis 0.8 M8 Alu 10X30mm | stuk | 10/50 |
| 10 | T2378891 | Kontaktbuis 1.0 M8 Alu 10X30mm | stuk | 10/50 |
| 10 | T2378894 | Kontaktbuis 1.2 M8 Alu 10X30mm | stuk | 10/50 |
| 11 | T2378893 | Kontaktbuis 1.6 M8 Alu 10X30mm | stuk | 10/50 |
| Tiphouders | | | | |
| 21 | T2378774 | Kontaktbuishouder 7/9W/380/411/511 M8 | stuk | 2/10 |
| 21 | T2378776 | Kontaktbuishouder 7/9W/380/411/511 M8 lang | stuk | 2/10 |
| Gasverdeler | | | | |
| 30 | TBI130P002031 | Gasverdeler 7/9W/411/511 bruin | stuk | 10/50 |
| 30 | T2378699 | Gasverdeler 7/9W/411/511 zwart | stuk | 10/50 |
| 30 | T2378694 | Gasverdeler 7/9W/411/511 keramisch | stuk | 1/5 |
| Liners | | | | |
| 100 | T2378785 | Liner 3M 1.0-1.2 | stuk | 1 |
| 100 | T2378795 | Liner 4M 1.0-1.2 | stuk | 1 |
| 100 | T2378778 | Liner 5M 1.0-1.2 | stuk | 1 |
| 100 | T2378784 | Liner 3M 1.4-1.6 | stuk | 1 |
| 100 | T2378794 | Liner 4M 1.4-1.6 | stuk | 1 |
| 100 | T2378792 | Liner 5M 1.4-1.6 | stuk | 1 |
| Diversen | | | | |
| 50 | TBI173P101002 | Zwanehals Tbi 9W S 50° | stuk | 1 |
| 51 | TBI173P101001 | Zwanehals Tbi 9W L 50° | stuk | 1 |
| 52 | TBI173P101003 | Zwanehals Tbi 9W ALU 35° | stuk | 1 |
| 53 | TBI171P102021 | Isolatie 9W | stuk | 2/10 |

MIG toorts 7XE-Extractor

MIG toorts 7XE-Extractor - Lucht- en watergekoeld

4.2



| | | |
|---|---|---|
| <p>GAS & WATER GEKOELD</p> <p>We hebben 2 types toortsen: een watergekoelde 550 Amp en een gasgekoelde 320 Amp. beiden met 100% inschakelduur.</p> | | <p>HET VOORDEEL</p> <p>De Extractor is een zeer lichte toorts: slechts 1,3 kg (lichter dan een standaard 510 toorts). Vanwege de kleine afmetingen van de handgreep, zal de lasser geen verschil voelen tussen de Extractor en een conventionele lastoorts</p> |
| | <p>COMFORTABELE SCHAKELAAR</p> <p>Vanwege een volledig gesloten schakelaar systeem, kan er geen vuil in de micro-schakelaar komen.</p> |  |
| <p>SMALLE HANDGREEP</p> <p>Er is een mooie smalle handgreep ontwikkeld om maximum lascomfort mogelijk te maken.</p> |  | <p>DRAAIBARE ONDERSTEUNING</p> <p>Door een draaibare kabelondersteuning met volledige draaibaarheid komt er minder druk op de pols.</p> |

MIG toorts 7XE-Extractor

MIG toorts 7XE-Extractor - Luchtgekoeld

4.2

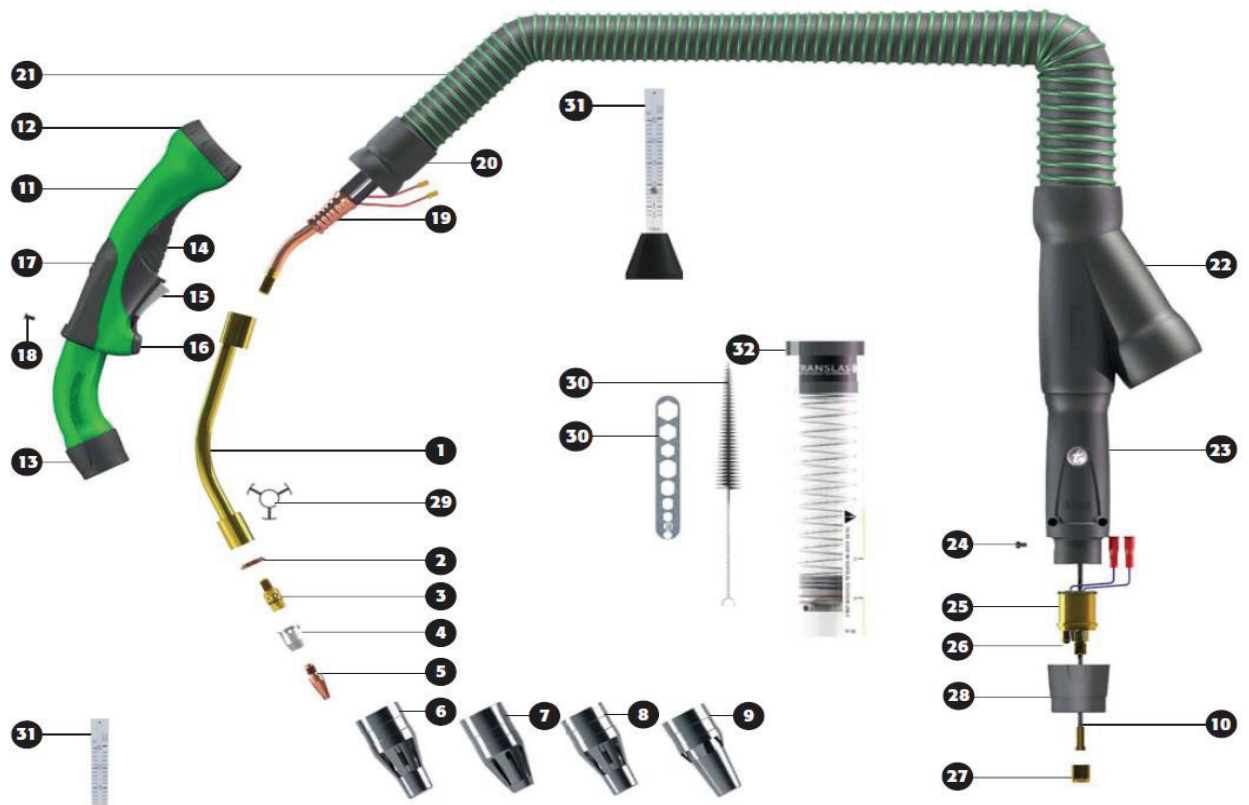

| Pos. nr. | Bestelnummer | Omschrijving | EC | VPE |
|----------|----------------|---|------|----------|
| | TR7XE3L | 7XE-Extractor rookafzuigtoorts, 3m, LK | stuk | 1 |
| | TR7XE4L | 7XE-Extractor rookafzuigtoorts, 4m, LK | stuk | 1 |
| | TR7XE5L | 7XE-Extractor rookafzuigtoorts, 5m, LK | stuk | 1 |
| | TR7XE6L | 7XE-Extractor rookafzuigtoorts, 6m, LK | stuk | 1 |

| | | | | |
|----|------------------|---|-------------|-------------|
| 7 | TR2407145 | Gasmondstuk konisch EXTRACTOR NW-10 | stuk | 2/5 |
| 6 | TR2407146 | Gasmondstuk konisch EXTRACTOR NW-12 | stuk | 2/5 |
| 8 | TR2407147 | Gasmondstuk konisch EXTRACTOR NW-14 | stuk | 2/5 |
| 9 | TR2407148 | Gasmondstuk konisch EXTRACTOR NW-14SP | stuk | 2/5 |
| 2 | TR3407145305 | Isolatie Extractor | stuk | 2/10 |
| 3 | TR1534583 | Kontakttiphouder M8 Extractor | stuk | 5/10 |
| 4 | TR154100 | Gasverdeler Extractor | stuk | 5/10 |
| 13 | TR366201 | Afsluitring zwart tbv van 7XE extractor greep mondstukzijde | stuk | 5 |
| | | Kontakttips | | |
| 5 | TR140108 | Kontakttip Extractor M8-0.8 | stuk | 1/50 |
| 5 | TR140110 | Kontakttip Extractor M8-1.0 | stuk | 1/50 |
| 5 | TR140112 | Kontakttip Extractor M8-1.2 | stuk | 1/50 |
| 5 | TR140116 | Kontakttip Extractor M8-1.6 | stuk | 1/50 |
| 5 | TR1401101 | Kontakttip Extractor M8-1.0 CuCrZr | stuk | 1/50 |
| 5 | TR1401121 | Kontakttip Extractor M8-1.2 CuCrZr | stuk | 1/50 |
| 5 | TR1401161 | Kontakttip Extractor M8-1.6 CuCrZr | stuk | 1/50 |
| 5 | TR1401102 | Kontakttip Extractor M8-1.0 Alu | stuk | 1/50 |
| 5 | TR1401122 | Kontakttip Extractor M8-1.2 Alu | stuk | 1/50 |
| 5 | TR1401162 | Kontakttip Extractor M8-1.6 Alu | stuk | 1/50 |

| Liners | | | | | |
|-----------|-----------------|---|--|-------------|------------|
| 10 | T2378295 | Liner PC blauw 4M 0,6-0,9mm | | stuk | 1/5 |
| 10 | T2378094 | Liner PC rood 3M 1,0-1,2mm | | stuk | 1/5 |
| 10 | T2378095 | Liner PC rood 4M 1,0-1,2mm | | stuk | 1/5 |
| 10 | T2378093 | Liner PC rood 5M 1,0-1,2mm | | stuk | 1/5 |
| 10 | T2378096 | Liner PC geel 3M 1.6mm | | stuk | 1/5 |
| 10 | T2378097 | Liner PC geel 4M 1.6mm | | stuk | 1/5 |
| 10 | T2378091 | Liner PC geel 5M 1.6mm | | stuk | 1/5 |
| | | | | | |
| 1 | TR3407040 | Zwanenhals Extractor LK | | stuk | 1 |
| | | | | | |
| 21 | TR340103 | Afzuigslang Extractor groen 36-44mm, 3m | | stuk | 1 |
| 21 | TR340104 | Afzuigslang Extractor groen 36-44mm, 4m | | stuk | 1 |
| 21 | TR340105 | Afzuigslang Extractor groen 36-44mm, 5m | | stuk | 1 |
| 21 | TR340106 | Afzuigslang Extractor groen 36-44mm, 6m | | stuk | 1 |
| | | Meten van afzuigdebiet en debiet van beschermgas | | | |
| 31 | 2375594 | Gasdebietmeter voor toorts | | stuk | 1 |
| 32 | TR371300 | Airflowmeter Extractor | | stuk | 1 |
| | | Onderhoudset Gasmondstuk | | | |
| 30 | TR371208 | Gereedschapset (Borstel en meervoudige sleutel) | | stuk | 1 |

MIG toorts 7XE-Extractor

MIG toorts 7XE-Extractor - Watergekoeld

4.2

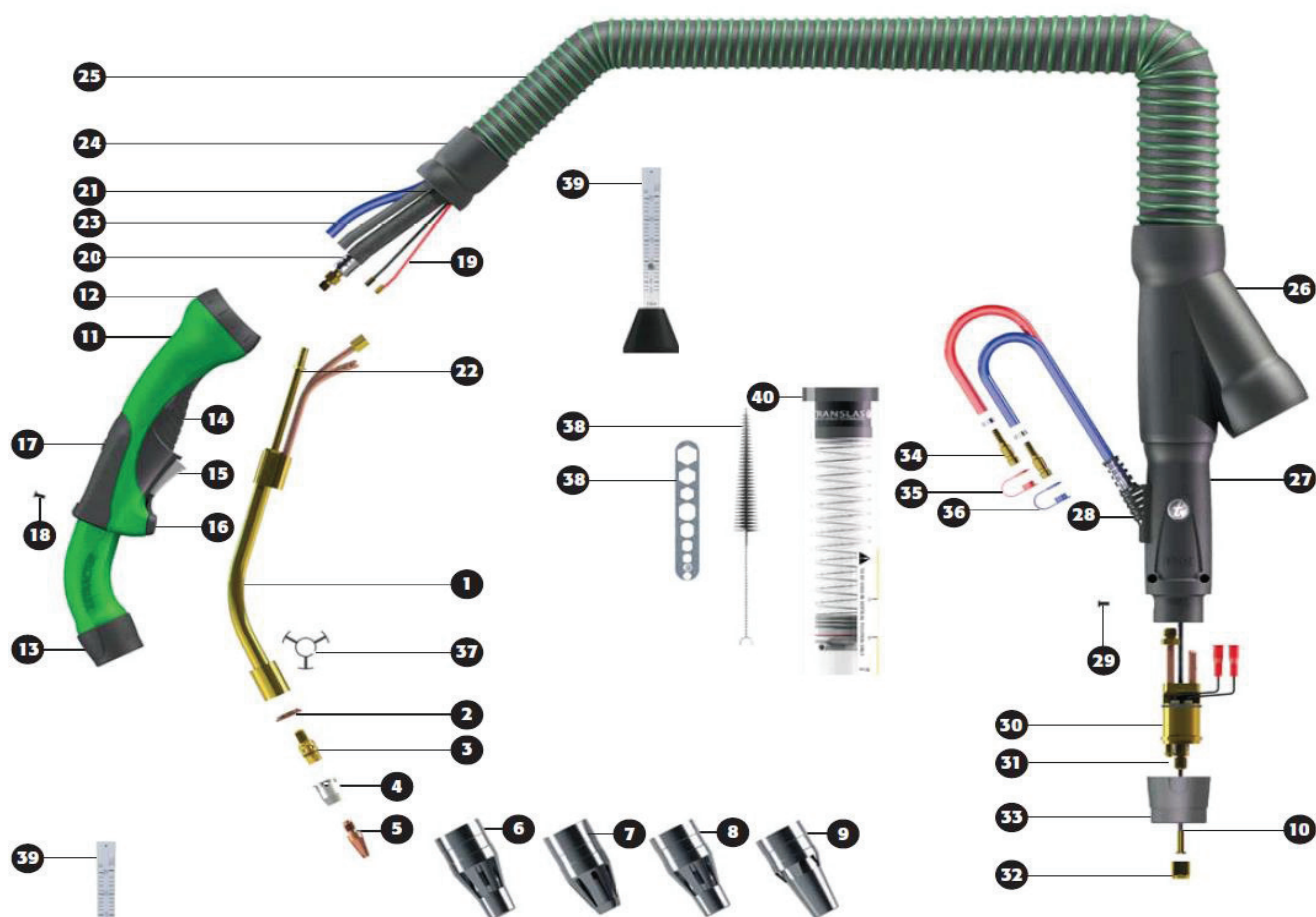

| Pos. nr. | Bestelnummer | Omschrijving | EC | VPE |
|----------|------------------|---|-------------|------------|
| | TR7XE3W | 7XE-Extractor rookafzuigtoorts, 3m, WK | stuk | 1 |
| | TR7XE4W | 7XE-Extractor rookafzuigtoorts, 4m, WK | stuk | 1 |
| | TR7XE5W | 7XE-Extractor rookafzuigtoorts, 5m, WK | stuk | 1 |
| | TR7XE6W | 7XE-Extractor rookafzuigtoorts, 6m, WK | stuk | 1 |
| 7 | TR2407145 | Gasmondstuk konisch EXTRACTOR NW-10 | stuk | 2/5 |
| 6 | TR2407146 | Gasmondstuk konisch EXTRACTOR NW-12 | stuk | 2/5 |
| 8 | TR2407147 | Gasmondstuk konisch EXTRACTOR NW-14 | stuk | 2/5 |
| 9 | TR2407148 | Gasmondstuk konisch EXTRACTOR NW-14 SP | stuk | 2/5 |
| 2 | TR3407145305 | Isolatieing Extractor | stuk | 2/10 |
| 3 | TR1534583 | Kontaktthouder M8 Extractor | stuk | 5/10 |
| 4 | TR154100 | Gasverdeler Extractor | stuk | 5/10 |
| 13 | TR366201 | Afsluitring zwart tbv van 7XE extractor greep mondstukzijde | stuk | 5 |

| MIG toorts 7XE-Extractor - Watergekoeld | | | | | 4.2 |
|---|------------------|--|-------------|-------------|-----|
| Pos. nr. | Bestelnummer | Omschrijving | EC | VPE | |
| Kontakttips | | | | | |
| 5 | TR140108 | Kontakttip Extractor M8-0.8 | stuk | 1/50 | |
| 5 | TR140110 | Kontakttip Extractor M8-1.0 | stuk | 1/50 | |
| 5 | TR140112 | Kontakttip Extractor M8-1.2 | stuk | 1/50 | |
| 5 | TR140116 | Kontakttip Extractor M8-1.6 | stuk | 1/50 | |
| 5 | TR1401101 | Kontakttip Extractor M8-1.0 CuCrZr | stuk | 1/50 | |
| 5 | TR1401121 | Kontakttip Extractor M8-1.2 CuCrZr | stuk | 1/50 | |
| 5 | TR1401161 | Kontakttip Extractor M8-1.6 CuCrZr | stuk | 1/50 | |
| 5 | TR1401102 | Kontakttip Extractor M8-1.0 Alu | stuk | 1/50 | |
| 5 | TR1401122 | Kontakttip Extractor M8-1.2 Alu | stuk | 1/50 | |
| 5 | TR1401162 | Kontakttip Extractor M8-1.6 Alu | stuk | 1/50 | |
| Liners | | | | | |
| 10 | T2378295 | Liner PC blauw 4M 0,6-0,9mm | stuk | 1/5 | |
| 10 | T2378094 | Liner PC rood 3M 1,0-1,2mm | stuk | 1/5 | |
| 10 | T2378095 | Liner PC rood 4M 1,0-1,2mm | stuk | 1/5 | |
| 10 | T2378093 | Liner PC rood 5M 1,0-1,2mm | stuk | 1/5 | |
| 10 | T2378096 | Liner PC geel 3M 1.6mm | stuk | 1/5 | |
| 10 | T2378097 | Liner PC geel 4M 1.6mm | stuk | 1/5 | |
| 10 | T2378091 | Liner PC geel 5M 1.6mm | stuk | 1/5 | |
| 1 | TR3407145 | Zwanenhals Extractor WK | stuk | 1 | |
| 25 | TR340103 | Afzuigslang Extractor groen 36-44mm, 3m | stuk | 1 | |
| 25 | TR340104 | Afzuigslang Extractor groen 36-44mm, 4m | stuk | 1 | |
| 25 | TR340105 | Afzuigslang Extractor groen 36-44mm, 5m | stuk | 1 | |
| 25 | TR340106 | Afzuigslang Extractor groen 36-44mm, 6m | stuk | 1 | |
| Meten van afzuigdebiet en debiet van beschermgas | | | | | |
| 39 | 2375594 | Gasdebietmeter voor toorts | stuk | 1 | |
| 40 | TR371300 | Airflowmeter Extractor | stuk | 1 | |
| Onderhoudset Gasmondstuk | | | | | |
| 38 | TR371208 | Gereedschapset (Borstel en meervoudige sleutel) | stuk | 1 | |

MIG toorts 7XE-Extractor - Mobiele Filterunit Plymovent

4.2



Draagbare hoogvacuüm lasrookafzuiger

Standaard voorzien van :

Dura-H filter, filteroppervlak 12m², HEPA-filter, aluminium voorfilter, automatische start/stop wielset, aanzuigslang 2,5m, 2 sets koolborstels

Vermogen : 2 x 1000W

| | | | | |
|---|--------------|---|------|---|
| 1 | LU7603001400 | Draagbare hoogvacuum unit PHV zonder trechters, 230V/1F~/50Hz | stuk | 1 |
|---|--------------|---|------|---|



Disposable filterpatroon voor PHV.
Met geïntegreerd aluminium voorfilter aan de onderzijde.

| | | | | |
|---|--------------|---------------------------------------|------|---|
| 2 | LU9850060230 | Filter Dura H 12m ² | stuk | 1 |
| 3 | LU9880020100 | Aanzuig-/afvoerslang, 2,5m, dia. 45mm | stuk | 1 |
| 3 | LU9880020110 | Aanzuig-/afvoerslang, 5m, dia. 45mm | stuk | 1 |
| 4 | LU0809010040 | Koppelstuk voor 2 slangen dia. 45mm | stuk | 1 |

MIG toorts 7XE-Extractor - Mobiele Filterunit Kemper

4.2



Eigenschappen

Filterbewaking
Traploze zuigkrachtregeling
Contaminatievrije filterwisseling
Automatische start/stop
Vonkenvanger

Toepassingen

Energiebesparing door geïntegreerde start/stop
Hoge veiligheid door contaminatievrije filterwisseling
Geschikt voor wisselende werkplekken dankzij laag gewicht en optionele trolley
Traploze zuigkrachtregeling

| | | | | |
|---|---------|--|------|---|
| 5 | KE65150 | MiniFil draagbare hoogvacuum unit, 230V/1F~/50Hz zonder toebehoren | stuk | 1 |
|---|---------|--|------|---|



| | | | | |
|---|-----------|--------------------------------|------|---|
| 6 | KE1090467 | Reservefilter 12m ² | stuk | 1 |
|---|-----------|--------------------------------|------|---|

| | | | | |
|---|------------|--------------------------------|------|---|
| 7 | KE93070004 | Zuigslang, dia 45mm, 2,5m lang | stuk | 1 |
|---|------------|--------------------------------|------|---|

| | | | | |
|---|------------|--------------------------------|------|---|
| 7 | KE93070005 | Zuigslang, dia 45mm, 5,0m lang | stuk | 1 |
|---|------------|--------------------------------|------|---|

| | | | | |
|---|------------|---------------------------------|------|---|
| 7 | KE93070006 | Zuigslang, dia 45mm, 10,0m lang | stuk | 1 |
|---|------------|---------------------------------|------|---|





Steeds te bestellen bij bestelling zuigslang

| | | | | |
|--|-----------|----------------|------|---|
| | KE1060076 | Koppeling man. | stuk | 1 |
|--|-----------|----------------|------|---|







| | | | | |
|---|-----------|----------------------|------|---|
| 8 | KE6515001 | Trolley voor MiniFil | stuk | 1 |
|---|-----------|----------------------|------|---|



Algemeen overzicht "KONTAKTBUIZEN" - "SPIRALEN"

| KONTAKTBUIZEN TBi | | | 4.3 | |
|---|---|-------------|--------------|--|
| Bestelnummer | Omschrijving | EC | VPE | |
|  | T2378380 Kontaktbuis 0.6 M6 6.3X25MM | stuk | 10/50 | |
| | T2378381 Kontaktbuis 0.8 M6 6.3X25MM | stuk | 10/50 | |
| | T2370005 Kontaktbuis 0.9 M6 6.3X25MM | stuk | 10/50 | |
| | T2378382 Kontaktbuis 1.0 M6 6.3X25MM | stuk | 10/50 | |
|  | T2378485 Kontaktbuis 0.6 M6 8X28mm | stuk | 10/50 | |
| | T2378481 Kontaktbuis 0.8 M6 8X28mm | stuk | 10/50 | |
| | T2370090 Kontaktbuis 0.9 M6 8X28mm | stuk | 10/50 | |
| | T2378482 Kontaktbuis 1.0 M6 8X28mm | stuk | 10/50 | |
| | T2378483 Kontaktbuis 1.2 M6 8X28mm | stuk | 10/50 | |
|  | T2378487 Kontaktbuis 0.8 M6 CuCrZr 8X28mm | stuk | 10/50 | |
| | T2370017 Kontaktbuis 0.9 M6 CuCrZr 8X28mm | stuk | 10/50 | |
| | T2378486 Kontaktbuis 1.0 M6 CuCrZr 8X28mm | stuk | 10/50 | |
| | T2378489 Kontaktbuis 1.2 M6 CuCrZr 8X28mm | stuk | 10/50 | |
|  | T2378877 Kontaktbuis 0.8 M8 10X30mm | stuk | 10/50 | |
| | T2378875 Kontaktbuis 0.9 M8 10X30mm | stuk | 10/50 | |
| | T2378881 Kontaktbuis 1.0 M8 10X30mm | stuk | 10/50 | |
| | T2378880 Kontaktbuis 1.2 M8 10X30mm | stuk | 10/50 | |
| | T2378876 Kontaktbuis 1.4 M8 10X30mm | stuk | 10/50 | |
| | T2378883 Kontaktbuis 1.6 M8 10X30mm | stuk | 10/50 | |
|  | T2378878 Kontaktbuis 0.8 M8 CuCrZr 10X30mm | stuk | 10/50 | |
| | T2378874 Kontaktbuis 0.9 M8 CuCrZr 10X30mm | stuk | 10/50 | |
| | T2378879 Kontaktbuis 1.0 M8 CuCrZr 10X30mm | stuk | 10/50 | |
| | T2378885 Kontaktbuis 1.2 M8 CuCrZr 10X30mm | stuk | 10/50 | |
| | T2378882 Kontaktbuis 1.6 M8 CuCrZr 10X30mm | stuk | 10/50 | |
| | T2378884 Kontaktbuis 2.4 M8 CuCrZr 10X30mm | stuk | 10/50 | |
|  | T2378892 Kontaktbuis 0.8 M8 Alu 10X30mm | stuk | 10/50 | |
| | T2378891 Kontaktbuis 1.0 M8 Alu 10X30mm | stuk | 10/50 | |
| | T2378894 Kontaktbuis 1.2 M8 Alu 10X30mm | stuk | 10/50 | |
| | T2378893 Kontaktbuis 1.6 M8 Alu 10X30mm | stuk | 10/50 | |

Algemeen overzicht "KONTAKTBUIZEN" - "SPIRALEN"

| Geleidingsspiralen TBI voor koolstofstaal | | | 4.3 | |
|---|--|-------------|------------|--|
| Bestelnummer | Omschrijving | EC | VPE | |
| Spiralen voor Gasgekoelde laspistolen | | | | |
| T2378294 | Geleidingsspiraal 0.6-0.9 3M Blauw | stuk | 1/5 | |
| T2378295 | Geleidingsspiraal 0.6-0.9 4M Blauw | stuk | 1/5 | |
| T2378296 | Geleidingsspiraal 0.6-0.9 5M Blauw | stuk | 1/5 | |
|  | | | | |
| T2378094 | Geleidingsspiraal 1.0-1.2 3M Rood | stuk | 1/5 | |
| T2378095 | Geleidingsspiraal 1.0-1.2 4M Rood | stuk | 1/5 | |
| T2378093 | Geleidingsspiraal 1.0-1.2 5M Rood | stuk | 1/5 | |
|  | | | | |
| T2378096 | Geleidingsspiraal 1.4-1.6 3M Geel | stuk | 1/5 | |
| T2378097 | Geleidingsspiraal 1.4-1.6 4M Geel | stuk | 1/5 | |
| T2378091 | Geleidingsspiraal 1.4-1.6 5M Geel | stuk | 1/5 | |
|  | | | | |
| TBI324P305034 | Geleidingsspiraal 2.0 3M Groen | stuk | 1/5 | |
| TBI324P305044 | Geleidingsspiraal 2.0 4M Groen | stuk | 1/5 | |
| TBI324P305054 | Geleidingsspiraal 2.0 5M Groen | stuk | 1/5 | |
| Blanke Spiralen voor Watergekoelde laspistolen | | | | |
| T2378294 | Geleidingsspiraal 0.6-0.9 3M Blauw | stuk | 1/5 | |
| T2378295 | Geleidingsspiraal 0.6-0.9 4M Blauw | stuk | 1/5 | |
| T2378296 | Geleidingsspiraal 0.6-0.9 5M Blauw | stuk | 1/5 | |
|  | | | | |
| T2378785 | Blanke spiraal 1.0 - 1.2 3M | stuk | 1/5 | |
| T2378795 | Blanke spiraal 1.0 - 1.2 4M | stuk | 1/5 | |
| T2378778 | Blanke spiraal 1.0 - 1.2 5M | stuk | 1/5 | |
|  | | | | |
| T2378784 | Blanke spiraal 1.4 - 1.6 3M | stuk | 1/5 | |
| T2378794 | Blanke spiraal 1.4 - 1.6 4M | stuk | 1/5 | |
| T2378792 | Blanke spiraal 1.4 - 1.6 5M | stuk | 1/5 | |
|  | | | | |
| T2378786 | Blanke spiraal 2.0-2.4 3M (vlakdraad) | stuk | 1/5 | |
| T2378796 | Blanke spiraal 2.0-2.4 4M (vlakdraad) | stuk | 1/5 | |

Algemeen overzicht "KONTAKTBUIZEN" - "SPIRALEN"

Geleidingspiralen TBI voor Alu en RVS (PA = sterker dan Teflon en koolstofgeleiders) 4.3



| Bestelnummer | Omschrijving | EC | VPE |
|--|-------------------------------|------|-----|
| COMBI-PA Spiralen voor Alu en RVS | | | |
| TBI328P20403A | Combi - PA spiraal 0.8-1.0 3M | stuk | 1/5 |
| TBI328P20404A | Combi - PA spiraal 0.8-1.0 4M | stuk | 1/5 |
| TBI328P20405A | Combi - PA spiraal 0.8-1.0 5M | stuk | 1/5 |
| TBI328P23473A | Combi - PA spiraal 1.2-1.6 3M | stuk | 1/5 |
| TBI328P23474A | Combi - PA spiraal 1.2-1.6 4M | stuk | 1/5 |
| TBI328P23475A | Combi - PA spiraal 1.2-1.6 5M | stuk | 1/5 |

COMBI-Teflon Spiralen voor Alu en RVS

| | | | |
|----------|---|------|-----|
| T2378170 | Combi - Teflon spiraal Blauw 0.8-1.0 3M | stuk | 1/5 |
| T2378171 | Combi - Teflon spiraal Blauw 0.8-1.0 4M | stuk | 1/5 |



Koolstof Spiralen voor Alu en RVS

| | | | |
|----------|--------------------------------|------|-----|
| T2378375 | Koolstof spiraal 0.6-1.0 3M ZW | stuk | 1/5 |
| T2378372 | Koolstof spiraal 1.0-1.2 3M ZW | stuk | 1/5 |
| T2378373 | Koolstof spiraal 1.0-1.2 4M ZW | stuk | 1/5 |
| T2378385 | Koolstof spiraal 1.2-1.6 3M ZW | stuk | 1/5 |
| T2378386 | Koolstof spiraal 1.2-1.6 4M ZW | stuk | 1/5 |
| T2378387 | Koolstof spiraal 1.2-1.6 5M ZW | stuk | 1/5 |

Messingeleider voor kunststof geleidingspiralen tbv Alu en RVS 4.3

Messingeleider te gebruiken in machinetoortskoppeling.
Hierdoor kan de spiraal, zoals voorgeschreven, perfect tot aan de aandrijfrollen geleid worden.

| Bestelnummer | Omschrijving | EC | VPE |
|--------------|-------------------------|------|-----|
| TBI329P54415 | Messing geleider teflon | stuk | 1 |

Pistoolkoppelstuk

Pistoolkoppelstukken / toortskoppelingen

4.4



| Pos. nr. | Bestelnummer | Omschrijving | EC | VPE |
|----------|--------------|-------------------------|------|-----|
| | 2300799 | Toortskoppeling M12X110 | stuk | 1 |

Aandrijfsystemen

2WD - EMIGMA 170 - 190 + Lastimig 16/20/21/31/41 + 26/36

4.4



| Pos. nr. | Bestelnummer | Omschrijving | EC | VPE |
|----------|--------------|--|------|-----|
| | 2300716 | Aandrijfrol 0.6 - 0.8 2WD | stuk | 1 |
| | 2300717 | Aandrijfrol 0.8 - 1.0 2WD | stuk | 1 |
| | 2300718 | Aandrijfrol 1.0 - 1.2 2WD | stuk | 1 |
| | 2300714 | Aandrijfrol 1.2 - 1.6 2WD | stuk | 1 |
| | 2300719 | Aandrijfrol 1.2 - 1.6R gevulde draad 2WD | stuk | 1 |
| | 2300720 | Aandrijfrol 1.0 - 1.2 Aluminium 2WD | stuk | 1 |

4WD - Lastimig 26 / 30 / 40 / 350 / 450 - Economig 350 / 450

4.4



| Pos. nr. | Bestelnummer | Omschrijving | EC | VPE |
|----------|--------------|--|------|-----|
| | 2300670 | Aandrijfeenheid 4WD 6042 of 7042+0.8-1.0+ISOPL | stuk | 1 |
| | 2300988 | Aandrijfrol 0.6 - 0.8 6042/7042 4WD | stuk | 1 |
| | 2300989 | Aandrijfrol 0.8 - 1.0 6042/7042 4WD | stuk | 1 |
| | 2300990 | Aandrijfrol 1.0 - 1.2 6042/7042 4WD | stuk | 1 |
| | 2300991 | Aandrijfrol 1.2 - 1.6 6042/7042 4WD | stuk | 1 |
| | 2300992 | Aandrijfrol 1.2 - 1.6R 6042/7042 4WD | stuk | 1 |
| | 2300993 | Aandrijfrol 1.6 - 2.4R 6042/7042 4WD | stuk | 1 |
| | 2300994 | Aandrijfrol 1.0 - 1.2A 6042/7042 4WD | stuk | 1 |
| | 2300995 | Aandrijfrol 1.2 - 1.6A 6042/7042 4WD | stuk | 1 |

Aandrijfsystemen - vervolg

4GWD - Lastimig 403 - 603 - 553 - 753 - Economig 350 / 450

4.4

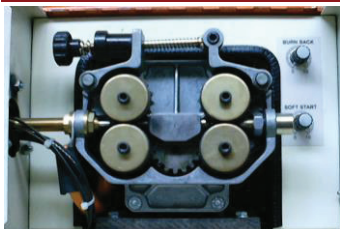

| Pos. nr. | Bestelnummer | Omschrijving | EC | VPE |
|----------|--------------|--|------|-----|
| | 2300620 | Aandrijfeenheid 4GWD 42V 140W 1.0-1.2 | stuk | 1 |
| | 2300649 | Aandrijftandwiel 4GWD | stuk | 1 |
| | 005104025 | Messing ring 4GWD | stuk | 1 |
| | 2300630 | Aandrijfrol 0.8 - 1.0 GWD | stuk | 1 |
| | 2300631 | Aandrijfrol 1.0 - 1.2 GWD | stuk | 1 |
| | 2300632 | Aandrijfrol 1.6 GWD gewone + gevulde draad | stuk | 1 |
| | 2300633 | Aandrijfdrukrol boven 4GWD gevulde draad | stuk | 1 |
| | 2300636 | Koolborstel 4GWD | stuk | 1 |
| | 2300637 | Koolborstelhouder 4GWD | stuk | 1 |
| | 2300644 | Draadgeleider midden 4GWD | stuk | 1 |

EMIGMA PULS - EMIGMA PULS 300 / 400 / 500

4.4



| Bestelnummer | Omschrijving | VPE | KV |
|---|---|------|----|
| Draadaanvoerrollen voor 4-rollen aandrijving EMIGMA PULS 300-400-500 | | | |
| Draadaanvoerrollen per stuk voor massieve draad | | | |
| R7502054 | Aandrijfrol 0.8/1.0 mm Staal/Rvs | stuk | 1 |
| R7502058 | Aandrijfrol 0.9/1.2 mm Staal/Rvs | stuk | 1 |
| R7502055 | Aandrijfrol 1.0/1.2 mm Staal/Rvs | stuk | 1 |
| R7502056 | Aandrijfrol 1.2/1.6 mm Staal/Rvs | stuk | 1 |
| Draadaanvoerrollen per stuk voor Aluminium draad | | | |
| R7502065 | Aandrijfrol 0.8/1.0 mm ALU | stuk | 1 |
| R7502066 | Aandrijfrol 1.0/1.2 mm ALU | stuk | 1 |
| R7502068 | Aandrijfrol 1.2/1.6 mm ALU | stuk | 1 |
| Draadaanvoerrollen per stuk voor gevulde draad | | | |
| R7502064 | Aandrijfrol 1.2/1.6 mm gevulde draad | stuk | 1 |
| R7502070 | Aandrijfrol 1.6/2.4 mm gevulde draad | stuk | 1 |
| Onderdelen voor draadaanvoerunit EMIGMA PULS 300-400-500 | | | |
| R7502039 | Tegendrukrol 30 EMIGMA PULS | stuk | 1 |
| R4000001 | Aandrijfrol op motoras 10mm | stuk | 1 |
| R4000003 | Aandrijfrol SF met bronzen bus | stuk | 1 |
| R7502049 | Kapilairbuis Ms 5x1.5mm 58.5mm | stuk | 1 |
| R7502048 | Kapilairbuis EMIGMA PULS 1.6 58.5mm | stuk | 1 |
| R7502053 | Steunbuis 57mm voor Teflon liner | stuk | 1 |
| R2900332 | Bevestigingsschroef voor aandrijftandwiel | stuk | 1 |
| R2900333 | Bevestigingsschroef voor beschermplaat | stuk | 1 |

Aandrijfsystemen - vervolg

| 4WD - EMIGMA 230-4 t/m 450-4 + EMIGMA S + Lastipuls 350-450 | | | | 4.4 | |
|---|--|---|----|-----|--|
|  | |  | | | |
| Bestelnummer | Omschrijving | VPE | KV | | |
| Draadaanvoerrollen voor 4-rollen aandrijving EMIGMA S 350-4WS - 450-4 WS | | | | | |
| Draadaanvoerrollen per stuk zonder tandkrans voor massieve draad | | | | | |
| R7502011 | Aandrijfrol 0.8 mm (+Lagerbus Brons) | stuk | 1 | | |
| R7502012 | Aandrijfrol 1.0 mm (+Lagerbus Brons) | stuk | 1 | | |
| R7502013 | Aandrijfrol 1.2 mm (+Lagerbus Brons) | stuk | 1 | | |
| R7502014 | Aandrijfrol 1.6 mm (+Lagerbus Brons) | stuk | 1 | | |
| Draadaanvoerrollen per stuk zonder tandkrans voor Aluminium draad | | | | | |
| R7502091 | Aandrijfrol Staal/Alu/Rvs 1.0 mm | stuk | 1 | | |
| R7502092 | Aandrijfrol Staal/Alu/Rvs 1.2 mm | stuk | 1 | | |
| R7502093 | Aandrijfrol Staal/Alu/Rvs 1.6 mm | stuk | 1 | | |
| Draadaanvoerrollen per stuk zonder tandkrans voor gevulde draad | | | | | |
| R7502007 | Aandrijfrol 1.2mm gevulde draad | stuk | 1 | | |
| R7502008 | Aandrijfrol 1.6mm gevulde draad | stuk | 1 | | |
| R7502009 | Aandrijfrol 1.8 tot 2.4mm gevulde draad | stuk | 1 | | |
| Onderdelen voor 4-rollen aandrijving EMIGMA S 350WS | | | | | |
| R7502038 | Tegendrukrol | stuk | 1 | | |
| R4000112 | Tandkrans | stuk | 1 | | |
| R4002092 | Aandrijftandwiel | stuk | 1 | | |
| R7502049 | Kapilairbuis 58,5mm EMIGMA S 350-4S - 450-WS | stuk | 1 | | |